



TEL: 1-866-XANATOS

INSTALLATION INSTRUCTIONS

PART # 17FP30SS/17FP30A

GRILLE GUARD FOR FORD F-150 09-10

PARTS LIST:

1	Grille Guard	2	3/8-16" x 1-1/4" Quick Release Bolts
1	Driver/Left Frame Mounting Bracket	4	12mm Plastic Washers
1	Passenger/Right Frame Mounting Bracket	4	3/8" x 1-1/4" Plastic Washers
1	Driver/Left Top Bracket	10	12-1.75mm x 35mm Hex Bolts
1	Passenger/Right Top Bracket	12	12mm x 32mm OD x 3mm Flat Washers
1	Driver/Left Top Support Bracket	12	12mm Lock Washers
1	Passenger/Right Top Support Bracket	2	12mm Hex Nuts
2	12mm Double Nut Plates	4	3/8" x 1-1/4" OD Flat Washers
2	12mm x 35mm Bolt Plates	2	3/8-16" Nylock Nuts
1	13mm ID x 42mm x 42mm x 6mm Square Washer		

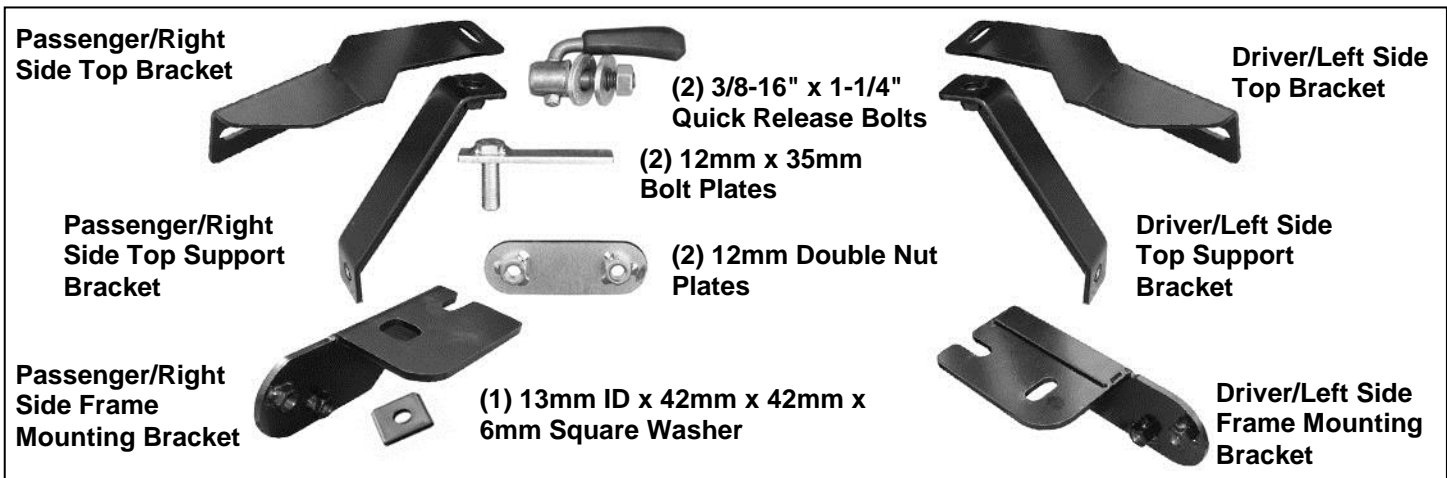
**PROCEDURE:**

- 1. REMOVE CONTENTS FROM BOX. VERIFY ALL PARTS ARE PRESENT. READ INSTRUCTIONS CAREFULLY BEFORE STARTING INSTALLATION. ASSISTANCE IS RECOMMENDED. CUTTING MAY BE REQUIRED.**
- 2. WARNING!** This Grille Guard is designed to swivel forward by partially loosening the Top Bracket Quick Release Bolts and the upper bolts on the Frame Mounting Brackets when the hood needs to be opened for service. Make sure that all hardware is fully tightened after closing the hood. **Read Page 6, "Opening and closing of hood,"** before installing the Grille Guard. **NOTE:** It may be necessary to remove/relocate the front license plate and license plate bracket. It is not required, but strongly recommended. If local/state law requires a license plate, a license plate relocation kit is available.
- 3. Installation on vehicles without Tow Hooks**
Insert the 12mm Double Nut Plate through the opening in the front of the frame, (driver and passenger side). Line up the threaded holes with the two holes in the bottom of the frame, **(Figure 1)**. **NOTE:** On some vehicles, it may be necessary to remove the lower plastic portion of the bumper to gain access to the ends of the frame rails. The indented pockets in the lower bumper may need to be cut out if closed to allow the Mounting Brackets to pass through.

Driver side Frame Bracket installation: Bolt the Frame Bracket to the Double Nut Plate with the supplied (2) 12mm x 35mm Hex Bolts, (2) 12mm Flat Washers and (2) 12mm Lock Washers, **(Figure 3)**. Snug but do not tighten the hardware at this time.

Passenger side Frame Bracket installation: In the rearmost location, bolt the Frame Bracket to the Double Nut Plate with the supplied (1) 12mm x 35mm Hex Bolt, (1)

12mm Flat Washer and (1) 12mm Lock Washer. In the forward location, use (1) 12mm x 35mm Hex Bolt, (1) 12mm Lock Washer and (1) Square Spacer Plate to cover the large opening in the Mounting Bracket, **(FIGURE 4)**. Snug but do not tighten the hardware at this time.

Installation on vehicles with Factory Tow Hooks

Remove the factory tow hooks, **(Figure 2)**. **NOTE:** This Grille Guard is not compatible with the factory tow hooks and they will not be reinstalled.

Driver side Frame Bracket installation: Bolt the Frame Bracket to the bottom of the frame with the factory hardware or the supplied (2) 12mm x 35mm Hex Bolts, (2) 12mm Flat Washers and (2) 12mm Lock Washers, **(Figure 3)**. Snug but do not tighten the hardware at this time.

Passenger side Frame Bracket installation: In the rearmost location, bolt the Frame Bracket to the frame with the factory hardware or the supplied (1) 12mm x 35mm Hex Bolt, (1) 12mm Flat Washer and (1) 12mm Lock Washer. In the forward location, use the factory hex bolt or the supplied (1) 12mm x 35mm Hex Bolt and (1) 12mm Lock Washer but add the (1) Square Spacer Plate to cover the large opening in the Mounting Bracket, **(FIGURE 4)**. Snug but do not tighten the hardware at this time.

4. Next, open the hood on the vehicle and locate the cross member behind the bumper cover. Locate the holes in the cross member for the Bolt Plate to secure the driver side Top Support Bracket. Insert (1) 12mm x 35mm Bolt Plate into the hole in the cross member behind the driver side of the bumper, **(FIGURE 5)**. Place the driver side Top Support Bracket onto the threaded end of the Bolt Plate and secure it with (1) 12mm Flat Washer, (1) 12mm Lock Washer and (1) 12mm Hex Nut, **(FIGURE 6)**. Snug but do not tighten hardware at this time. **IMPORTANT:** It is highly recommended that you cover the top of the plastic bumper cover during installation to prevent damage to the painted finish on the vehicle, **(FIGURE 7)**.
5. Select the driver side Top Bracket and attach it to the previously installed Top Support Bracket with (1) 12mm x 35mm Hex Bolt, (1) 12mm Flat washer and (1) 12mm Lock Washer, **(FIGURE 6)**. Snug hardware but do not tighten at this time.
6. Repeat **Steps 4-5** for passenger side Top Bracket and Top Support Bracket installation.
7. Move the driver side and passenger side Frame Mounting Brackets in as far as possible, (loosen hardware slightly if necessary). With help, place the Grille Guard face down on a clean surface in front of the vehicle. **NOTE:** Use the foam packaging materials to protect the finish on the Grille Guard. Position the mounting tabs on the Grille Guard up to the outside of the driver side Mounting Bracket and line up the lower hole in the Frame Mounting Bracket with the lower hole in the Grille Guard, **(FIGURE 8)**. Insert (1) 12mm Plastic Washer between the Mounting Bracket and the Grille Guard and bolt together with the included (1) 12mm x 35mm Hex Bolt, (1) 12mm lock Washer, (2) 12mm Flat Washers and (1) 12mm Hex Nut, **(FIGURE 9)**. Repeat this step for the passenger side. Snug but do not tighten hardware at this time.
8. With assistance, use the two previously installed Hex Bolts as a hinge and rotate the Grille Guard up to the vehicle. Line up the two remaining holes in the Frame Mounting Brackets with the holes in the Grille Guard. Insert a 12mm Plastic Washer between the Mounting Bracket and the Grille Guard on both sides of the vehicle as described in **Step 7**. Line up the holes and secure with (2) 12mm x 35mm Hex Bolts, (2) 12mm lock Washers, (4) 12mm Flat Washers and (2) 12mm Hex Nuts. Snug the hardware but do not tighten at this time.
9. Next, move to the driver side Top Bracket installed in **Step 5**. Line up the slotted hole in the Top Bracket with the hole in the Grille Guard. Insert (1) 3/8" Plastic Washer between the Top Bracket and the Grille Guard, **(FIGURE 10)**. Line up the hole in the Plastic Washer with the hole in the Grille Guard and the slot in the Top Bracket. Insert (1) 3/8" Quick Release Bolt and (1) 3/8" Flat Washer through the Grille Guard, Plastic Washer and Top Bracket. Secure the Quick Release Bolt with (1) 3/8" Plastic Washer, (to protect the finish on the Top Bracket), (1)

3/8" Flat Washer and (1) 3/8" Nylon Lock Nut, **(FIGURE 11)**. Snug but do not tighten at this time. Repeat this step for the passenger side installation.

10. With the hood open, push the Grille Guard back until it is upright. Align, center and adjust the Grille Guard properly and tighten all Mounting Bracket and Support Bracket hardware. Release the levers on the Quick Release Bolts, **(FIGURE 12A)** and loosen the top Hex Bolts on the Frame Mounting Bracket. **WARNING!** Do not loosen the bolts all the way. Loosen hardware only enough to move the Grille Guard. Damage to the truck or Grille Guard may occur.
11. Pull the Grille Guard forward, away from the vehicle, **(FIGURE 13)**.
12. Carefully close the hood and check for clearance between the Top Bracket and the factory grille. Adjust the Brackets for fit as necessary. **IMPORTANT:** Always make sure that the hood and grill will clear the Grille Guard before closing the hood.
13. Push the Grille Guard back towards the vehicle until it is upright, check the alignment again and adjust the Grille Guard as required. Tighten all Mounting Bracket hardware including the Quick Release Bolts, **(FIGURE 12B)**.
14. Do periodic inspections to the installation to make sure that all hardware is secure and tight.

To protect your investment, wax this product after installing. Regular waxing is recommended to add a protective layer over the finish. Do not use any type of polish or wax that may contain abrasives that could damage the finish.

For stainless steel: Aluminum polish may be used to polish small scratches and scuffs on the finish. Mild soap may be used also to clean the Grille Guard.

For gloss black finishes: Mild soap may be used to clean the Grille Guard.

Driver Side Installation Pictured

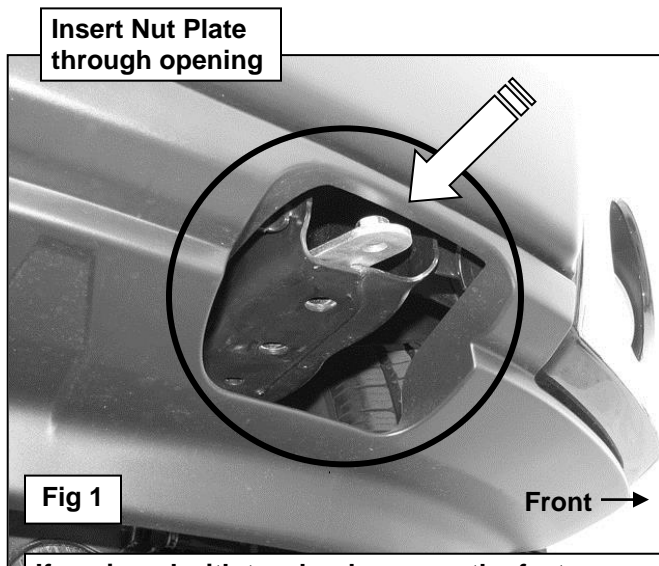

If equipped with tow hooks, reuse the factory hardware to bolt the Frame Mounting Bracket to the vehicle. If not equipped, use the supplied:

- (1) 12mm Double Nut Plate
- (2) 12mm x 35mm Hex Bolts
- (2) 12mm Lock Washers
- (2) 12mm 32mm OD x 3mm Flat Washers

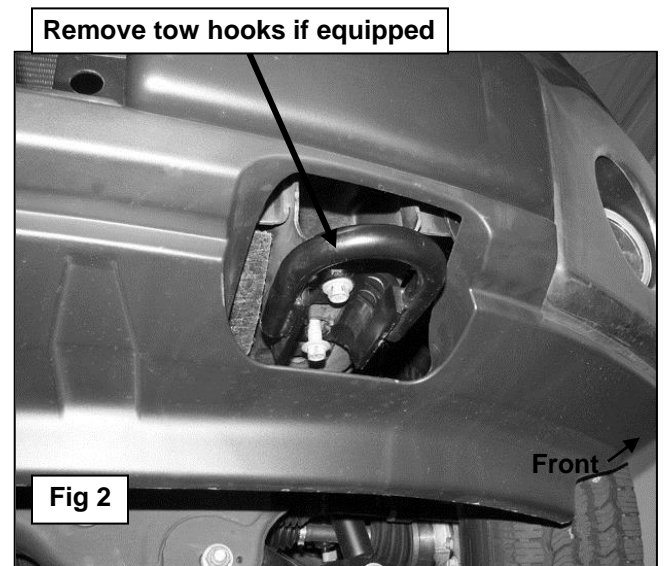

NOTE: On vehicles without tow hooks, the area circled in Figure 1 may be covered by an indented plastic panel. Cut or remove the panel as required to gain access to the front of the frame rail to allow bottom brackets to pass through

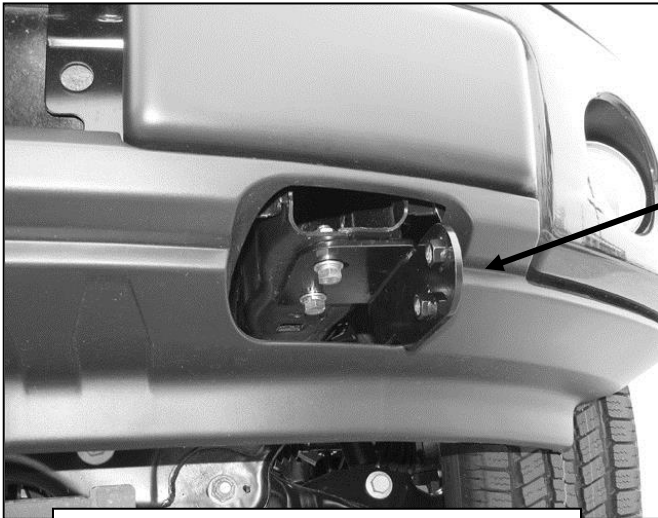

(Fig 3) Driver side installation pictured

If equipped with tow hooks, reuse the factory hardware to bolt the Frame Mounting Bracket to the vehicle. If not equipped, use the supplied
12mm Double Nut Plate
(2) 12mm x 35mm Hex Bolts
(2) 12mm Lock Washers
(2) 12mm 32mm OD x 3mm Flat Washers

IMPORTANT: The passenger side Frame Mounting Bracket is provided with more adjustability to compensate for various model years and frame configurations. The Bracket requires the Square Spacer for proper installation

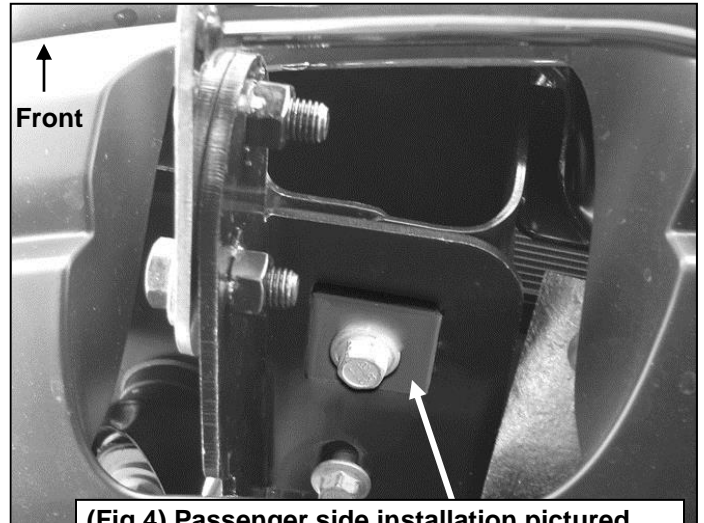

(Fig 4) Passenger side installation pictured
PASSENGER SIDE ONLY: Use the Square Spacer on the forward mounting bolt to cover the large opening in the Mounting Bracket

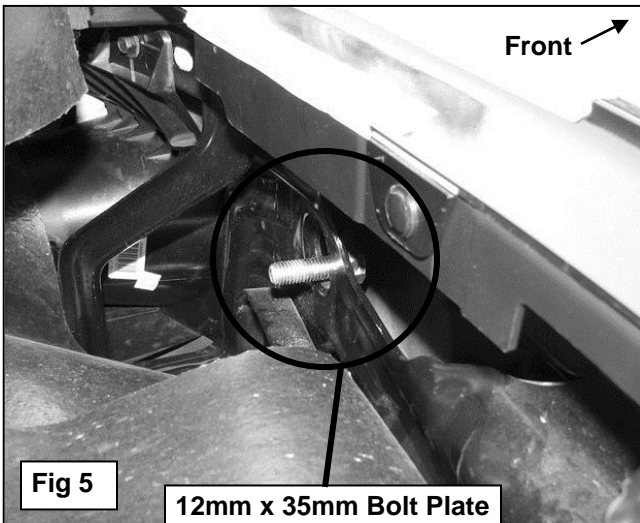

Fig 5

12mm x 35mm Bolt Plate
12mm Lock Washer
12mm 32mm OD x 3mm Flat Washers
12mm Hex Nut

12mm x 35mm Hex Bolt
12mm Lock Washer
(2) 12mm 32mm OD x 3mm Flat Washers
12mm Hex Nut

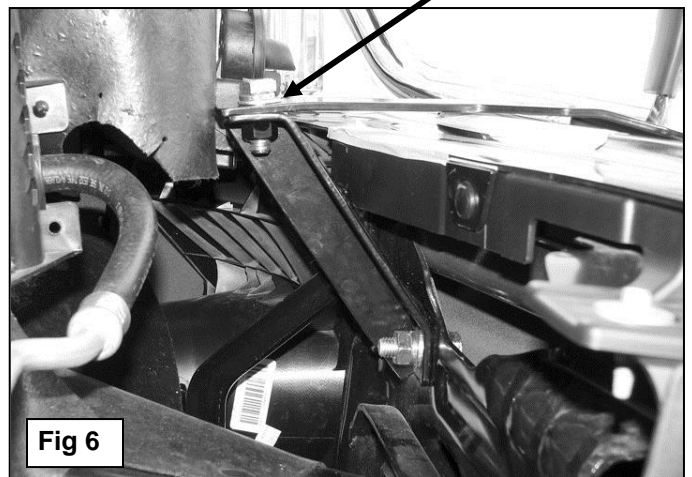
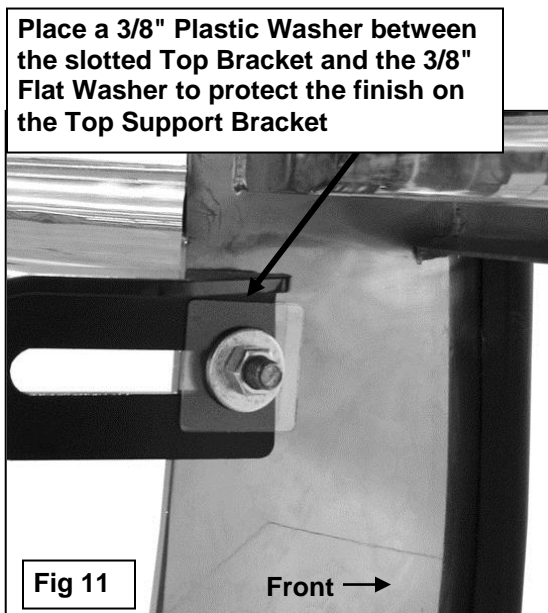
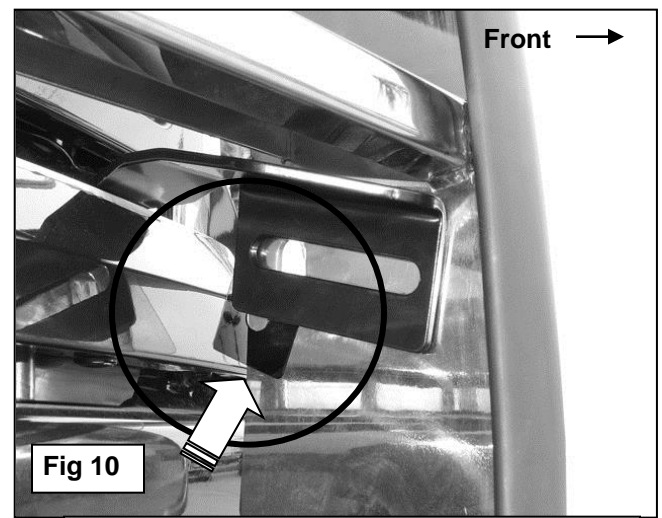
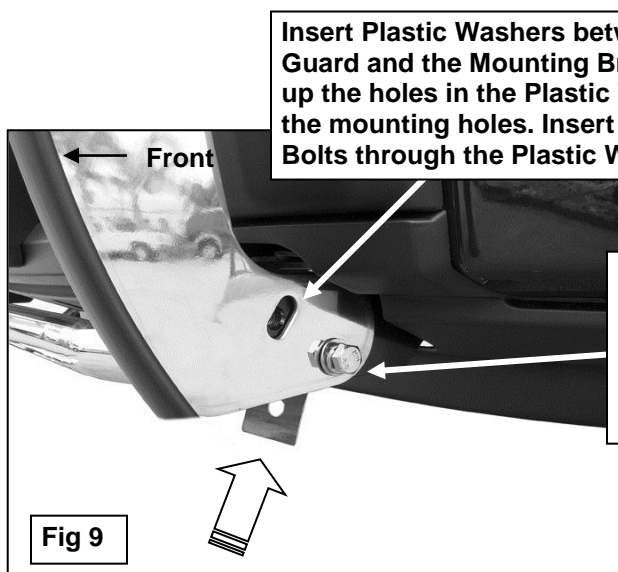
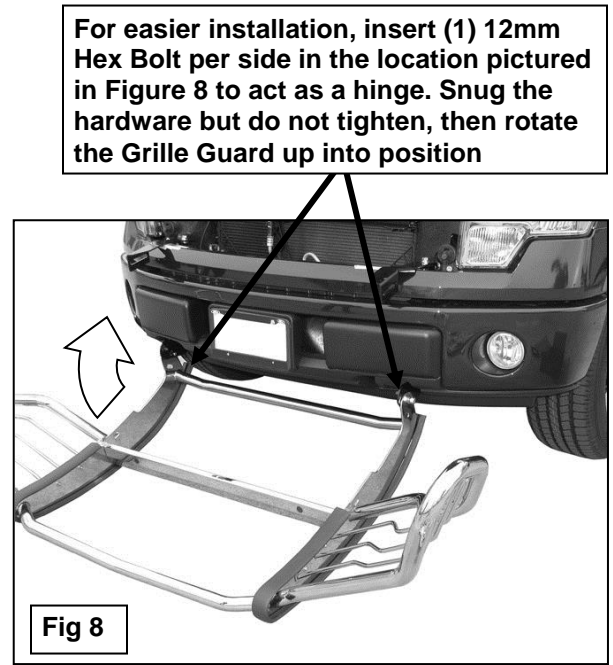
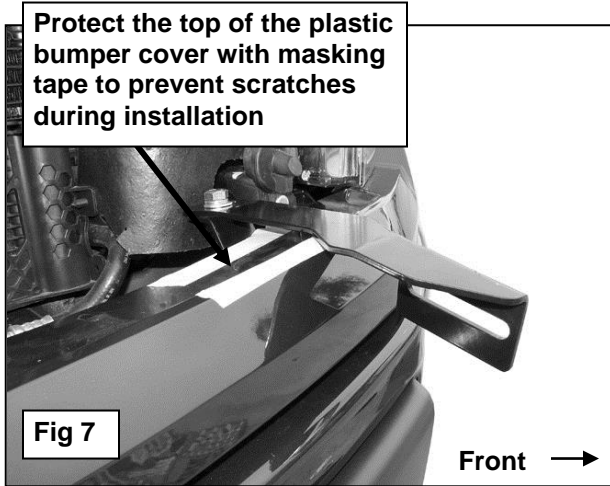
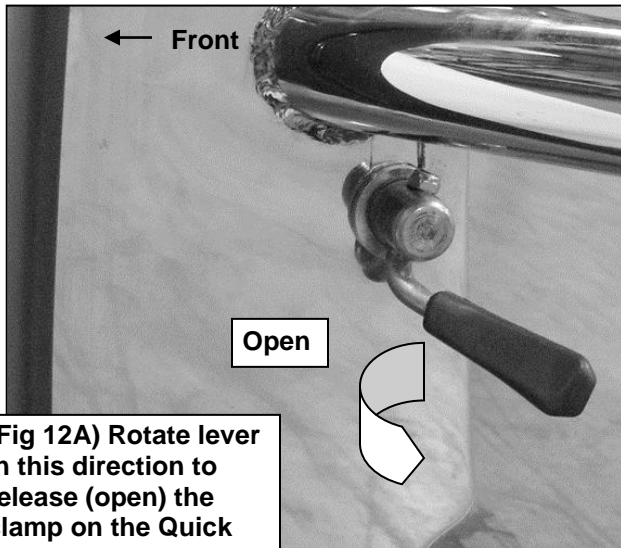

Fig 6

Driver Side Installation Pictured



Driver Side Installation Pictured

(Fig 12A) Rotate lever in this direction to release (open) the clamp on the Quick Release Bolt

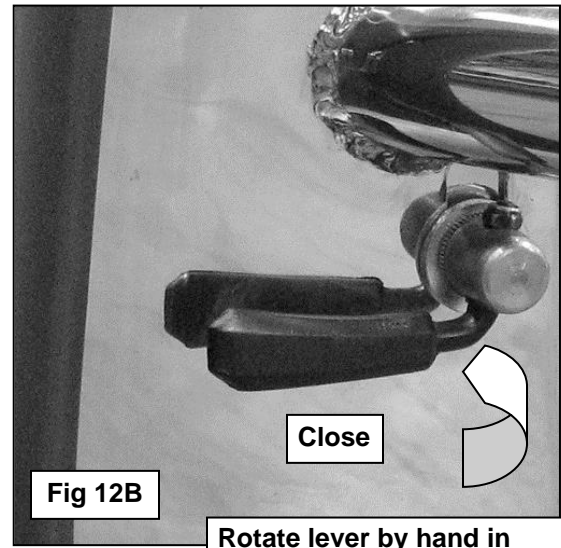

Fig 12B

Rotate lever by hand in opposite direction to close the clamp on the Quick Release Bolt. Tighten or loosen the 3/8" Nylon Lock Nut to adjust the clamping pressure on the Quick Release Bolt. When properly adjusted, it should require reasonable force (by hand) to completely close the lever

To open the hood, release the lever on the Quick Release Bolts. Try to pull the Grille Guard forward. If Necessary, loosen the Hex Bolts securing the Grille Guard to the Mounting Brackets. Only loosen the hardware enough to move the Grille Guard

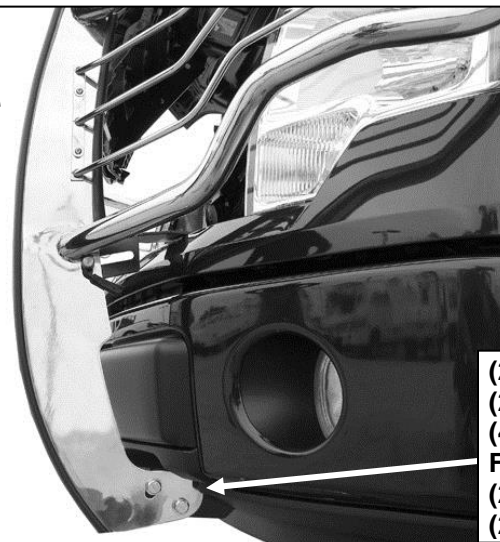
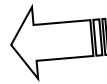

Fig 13

(2) 12mm x 35mm Hex Bolts
(2) 12mm Lock Washers
(4) 12mm 32mm OD x 3mm Flat Washers
(2) 12mm Hex Nuts
(2) 12mm Plastic Washers

Opening and closing the hood

1. Rotate the levers on the two Quick Release Bolts 1/2 turn to loosen the clamp on the Top Support Bracket, **(FIGURE 12A)**. Try to pull the Grill Guard forward. If necessary, slightly loosen the top hex bolts on the Frame Mounting Brackets to pivot the Grille Guard away from the vehicle. Carefully pull on the Grille Guard until it is fully extended away from the vehicle, **(Figure 13)**. **WARNING!** Do not loosen the bolts all the way. Damage to the truck or Grille Guard may occur. Only loosen the bolts enough to move the Grille Guard.
2. Pull the hood release and open the hood.
3. **IMPORTANT:** Before closing the hood, always check to make sure that the Grille Guard hasn't been pushed back to its closed position and it is fully extended away from the vehicle, then close the hood.
4. Once the hood is completely closed, push the Grille Guard back to its closed, upright position and tighten all hardware on the Grille Guard. Rotate the lever on the Quick Release clockwise to tighten, **(FIGURE 12B)**. No tools are required to close the Quick Release levers. It will require some effort to open and close by hand when properly adjusted.
5. Do periodic inspections to the installation to make sure that all hardware is secure and tight.